

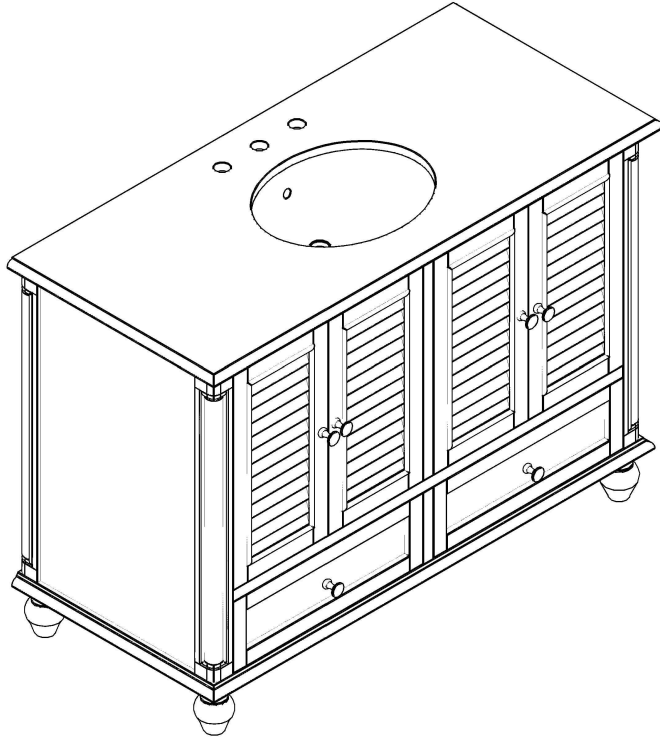

Assembly Instructions

VF30548



PART#	DESCRIPTION	PARTS	QTY
A	Feet		4pcs

hardware

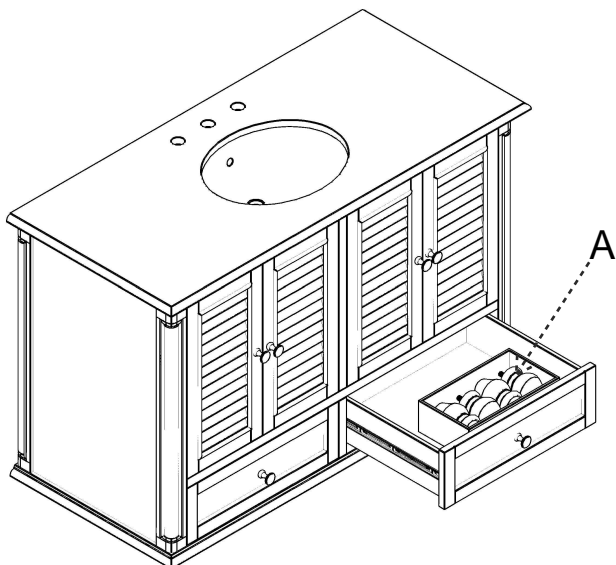

1. Open the drawer and take out the KD legs

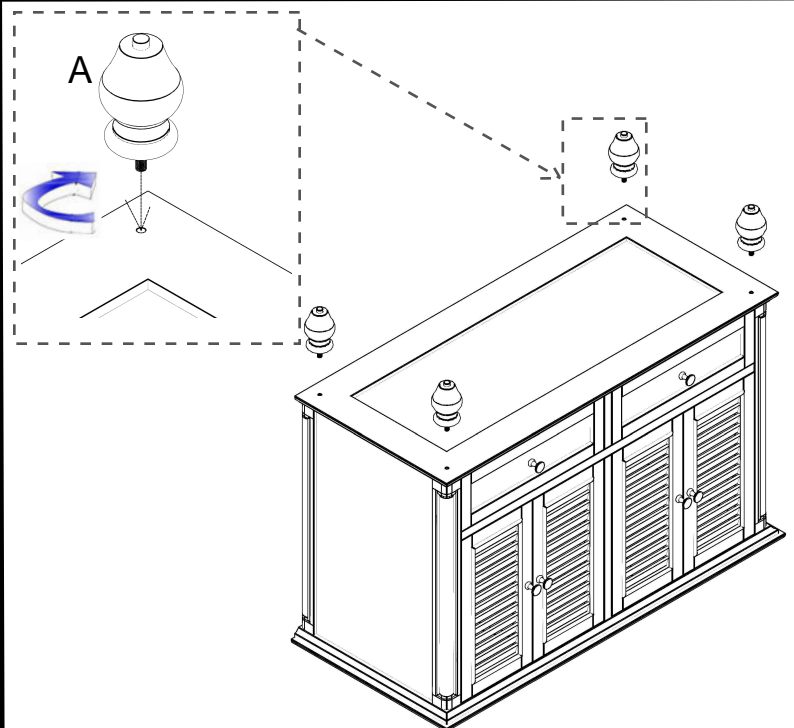

2. Twist the legs into the reserved screw hole on the bottom